



University of
Nottingham

UK | CHINA | MALAYSIA

Bearings 1 – Sliding bearings Self lubricating, hydrostatic and hydrodynamic bearings

Dr Khaled Goher

Coates B82

Khaled.goher@nottingham.ac.uk

Adapted from the work of Dr Simon Lawes

Outlines

- The Use of Bearings
- Overview of Bearings
- Important Terminologies and Calculations
- Selection of Bearings

Learning Objectives

- Understand types and working principles of bearings
- Understand the general use of bearings
- To discuss bearings terminologies and relevant calculations
- To select a suitable type of bearings for various applications and functions

Bearings



deep groove ball bearing



self-aligning roller bearing



cylindrical roller bearing



self-aligning ball bearing



bearing block



tapered roller bearing



thrust bearing



angular contact ball bearing



needle roller bearing



Bearings

Used mainly **to prevent or reduce friction forces** (which generate heat that wastes energy and result in wear) when **two surface are in contact** and one is moving with respect to other.

So the **function of the bearing is to guide the movement of one part relative to another with minimum friction and maximum accuracy.**

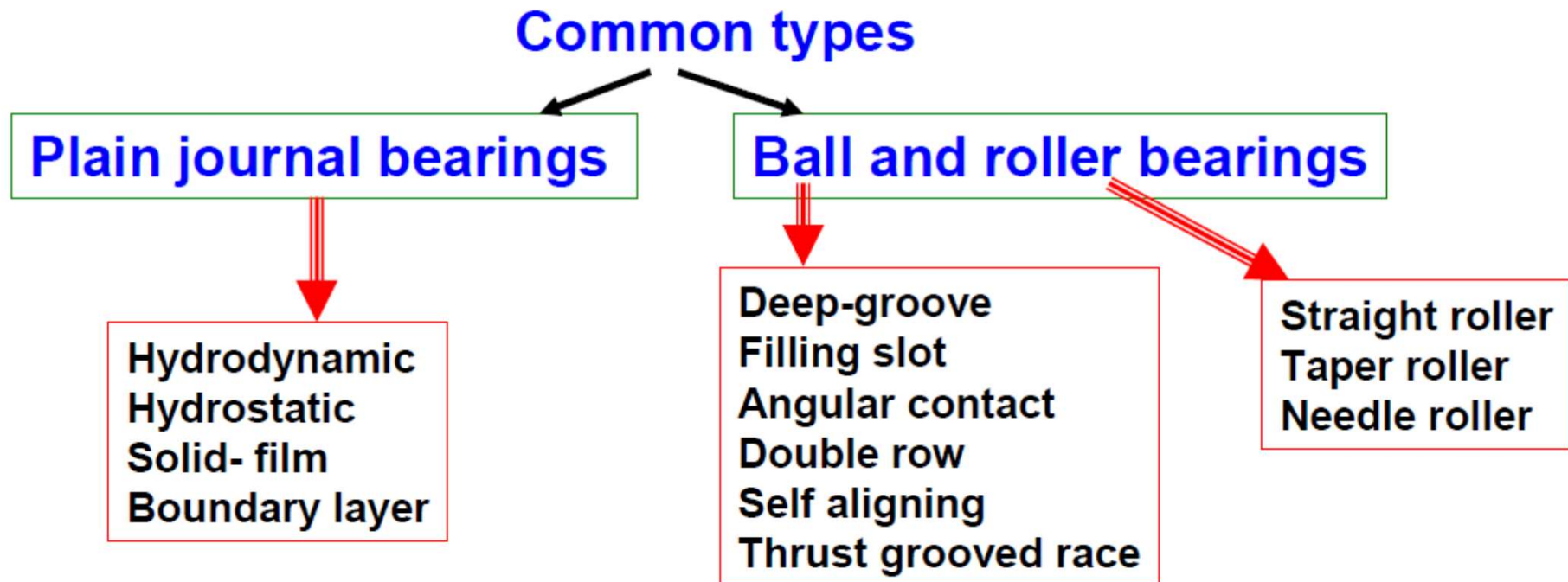

Plain Journal Bearings

- Journal bearings are used to support rotating shafts which are loaded in radial direction.
- The word **journal** is used for a shaft.
- The bearing basically consist of an inserted of some **suitable material** which is fitted between the shaft and the support
- The insert may be a **aluminium alloy, copper alloy, bronze**, etc..
- The insert **provides lower friction** and **less wear** than if the shaft just rotated in a hole in the support
- The bearing may be **dry rubbing bearing** or **lubricated**.

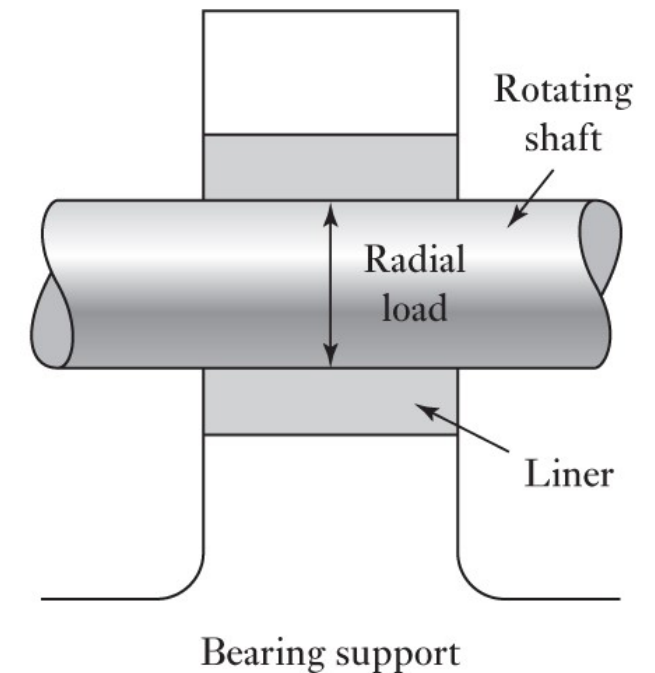
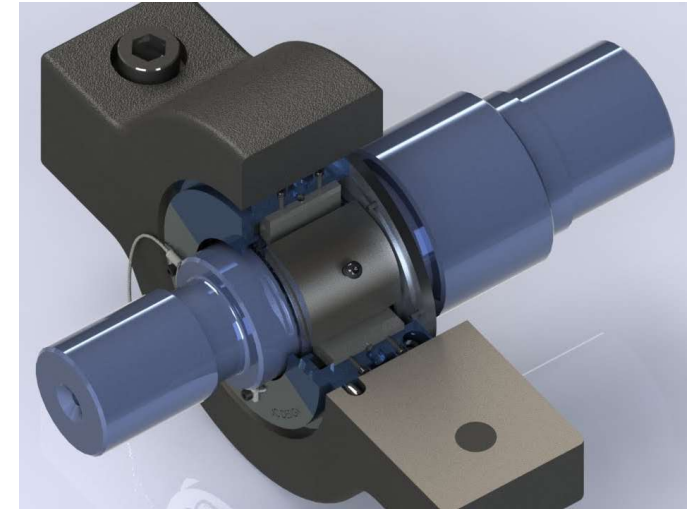

Plain Journal Bearings

The lubrication may be:

Hydrodynamic: consists of shaft rotating continuously in oil. The load is carried by pressure degenerated in the oil as a result of the shaft rotating

Hydrostatic: is used to avoid excessive wear at start-up occurred in hydrodynamic types and when there is only a low load, oil is pumped into the load bearing area at a high-enough pressure to left the shaft off the metal when at rest.

Solid- film: is a coating of a solid material such as graphite or molybdenum disulphide

Boundary layer: is a thin layer of lubricant which adheres to the surface of the bearing.

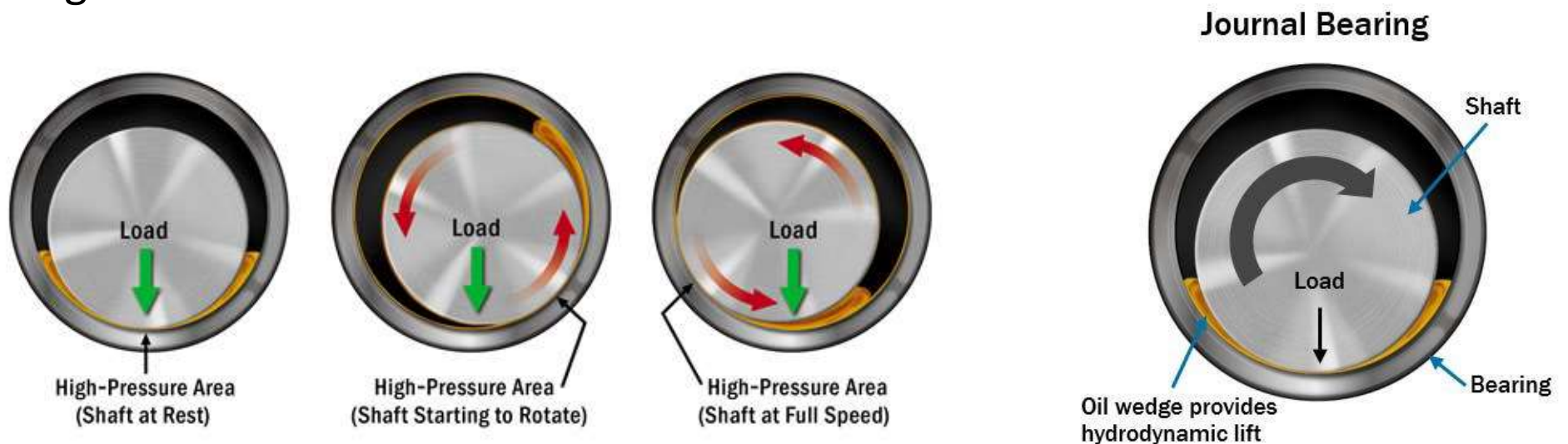

Ball and Roller Bearings

- With this type the main load is transferred from the rotating shaft to its support by rolling contact rather than sliding contact.
- A rolling element bearing consists of four main elements: an **inner race**, an **outer race**, the **rolling element of either balls or rollers** and a **cage** to keep the rolling elements apart.

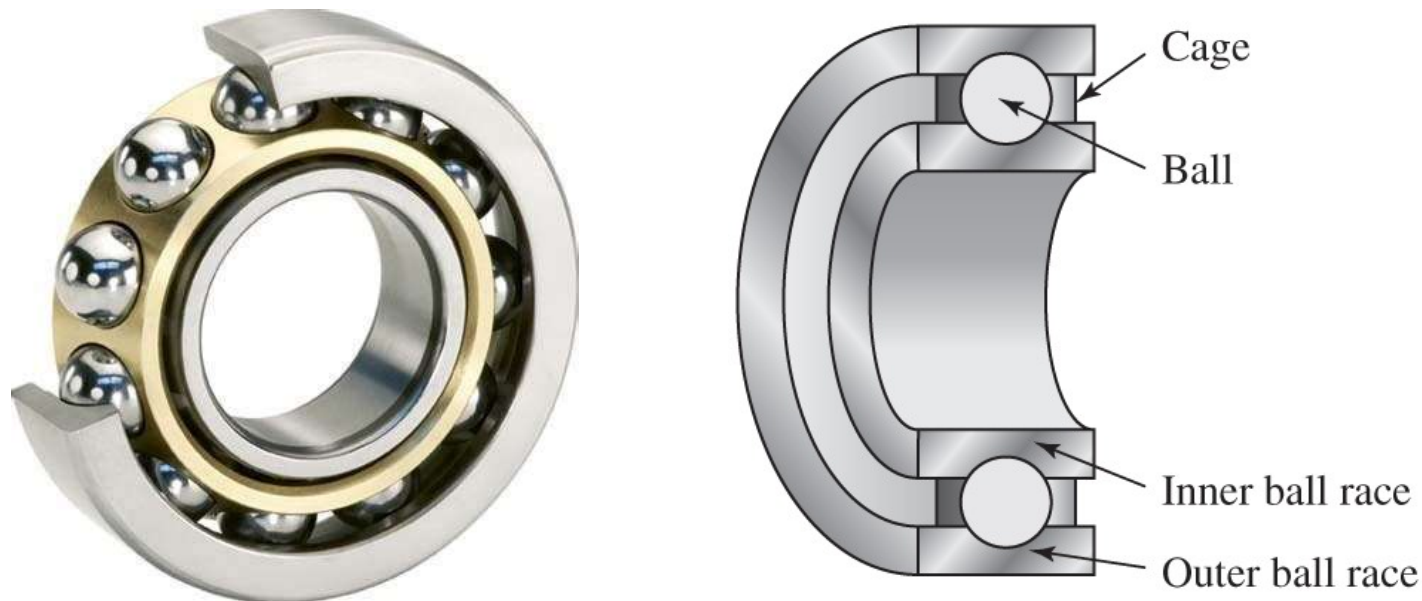

Bearings in Mechanical Systems

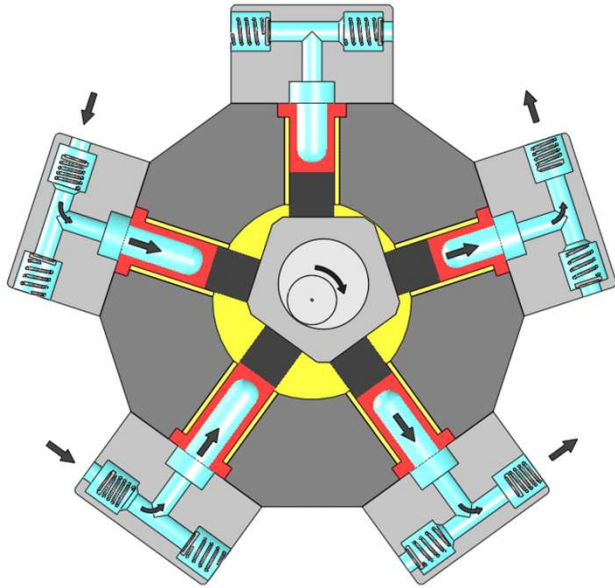

Bearings

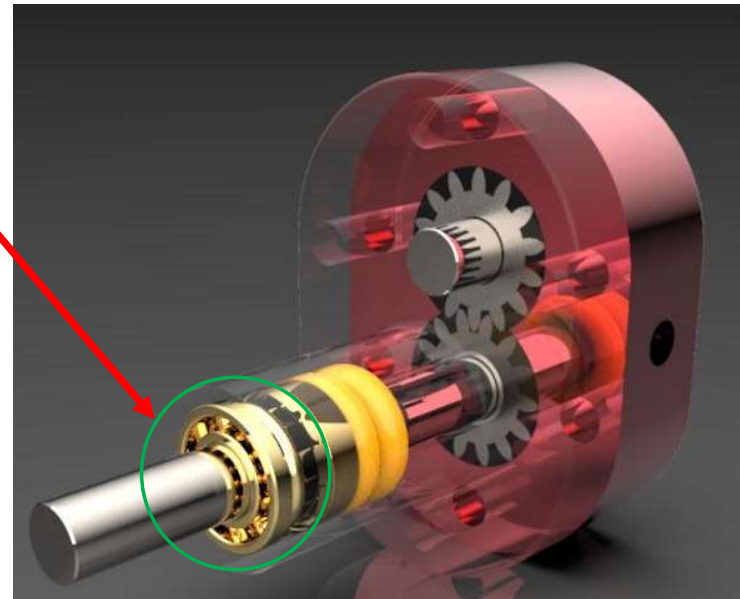
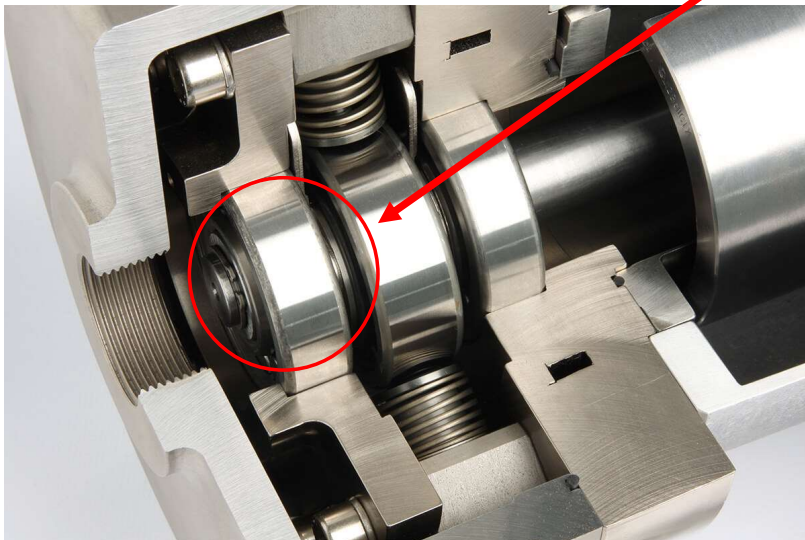

Bearings in Mechanical Systems

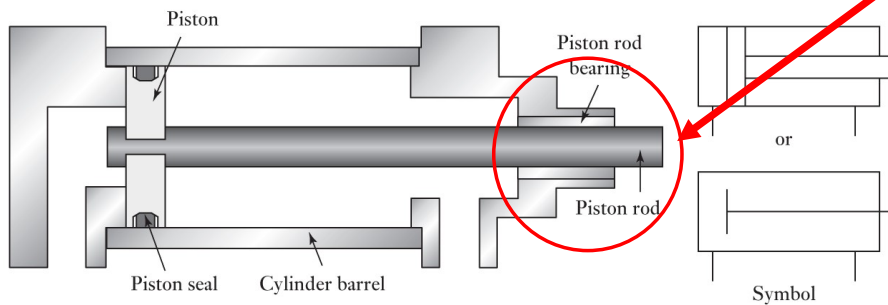
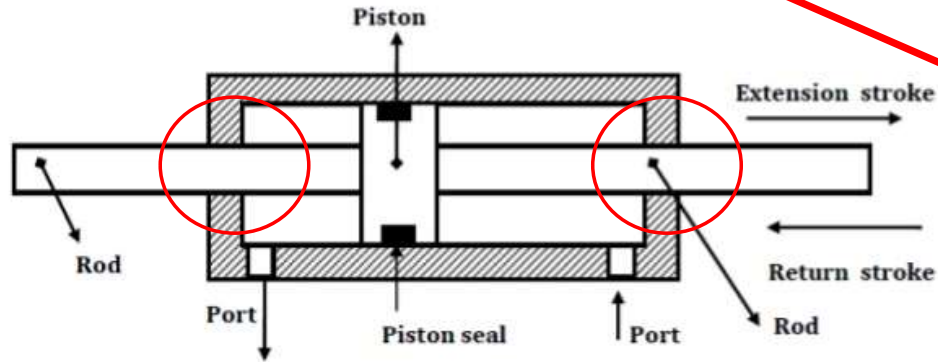
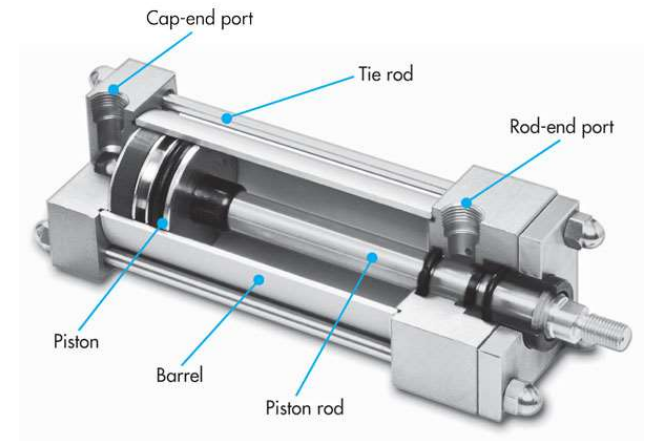
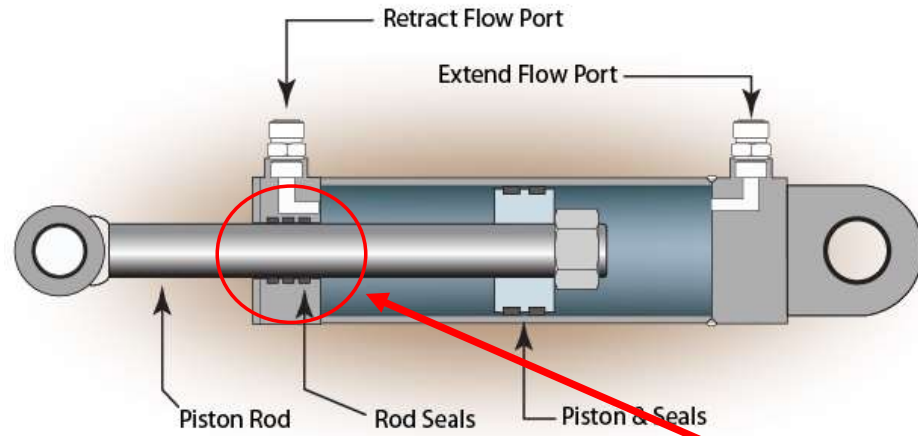

Bearings



Bearings in Mechanical Systems

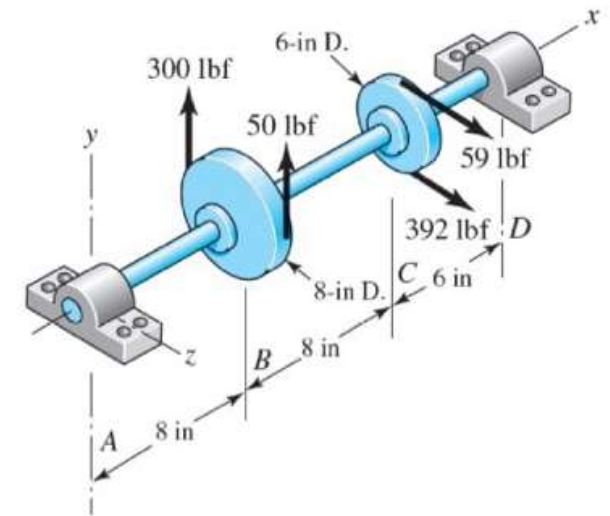
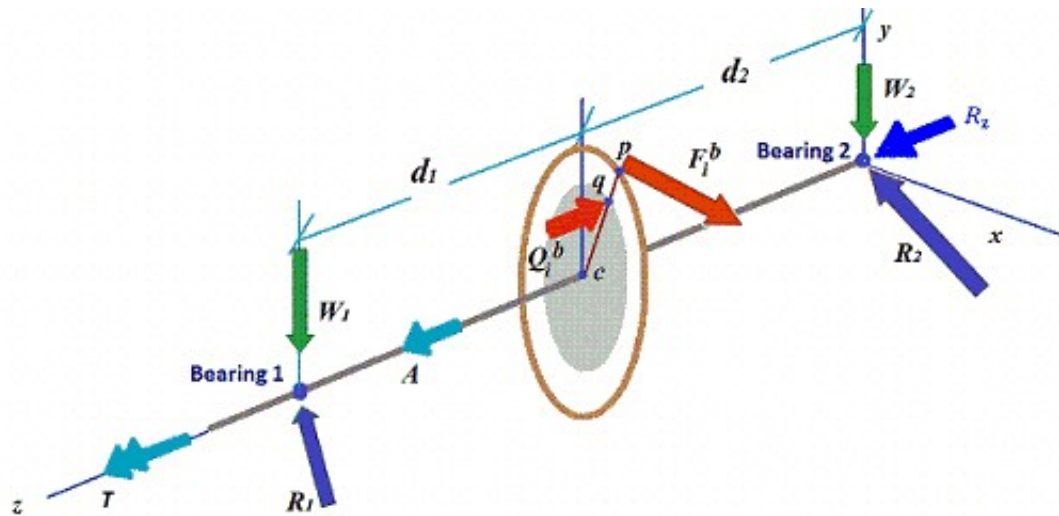
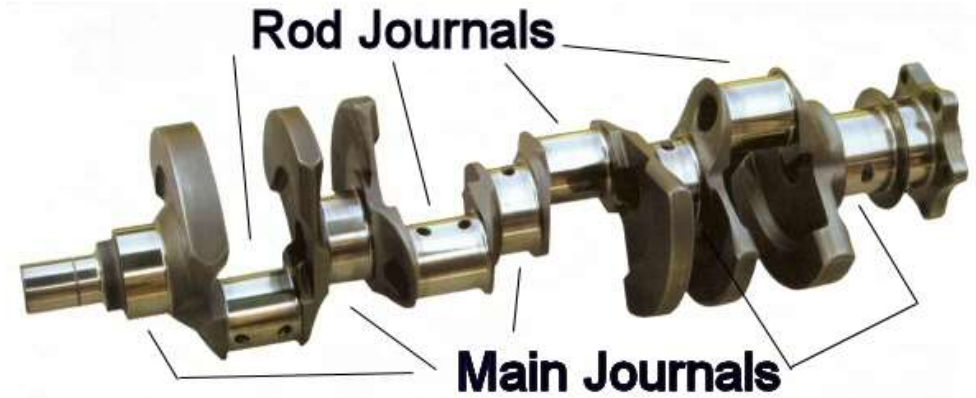
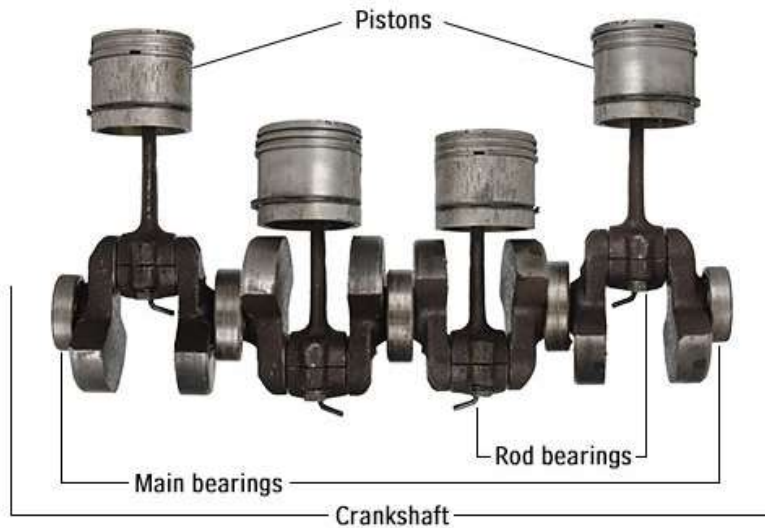

Low friction:

- Bearings
- Cams
- Piston rings
- Gears
- Seals
- Valve stems

Generally we want low friction;

Forces/Moments at Bearings

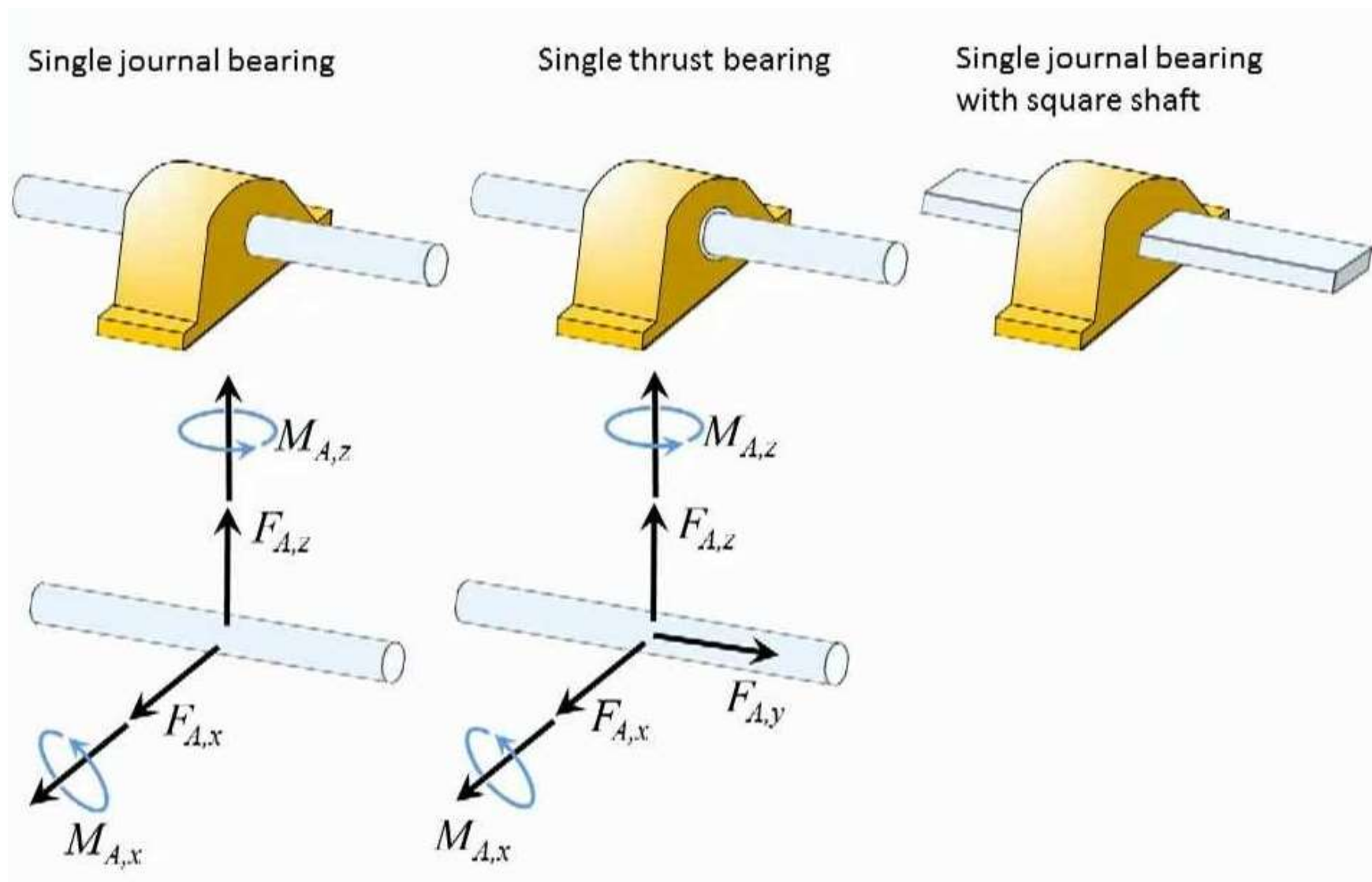

Minimising unnecessary vibration transmission

Sometimes we want high friction



High friction

- Tyres
- Shoes
- Brakes



Sometimes the friction must be precise;



Choice 1



Choice 2



Choice 3



Bearing Selection

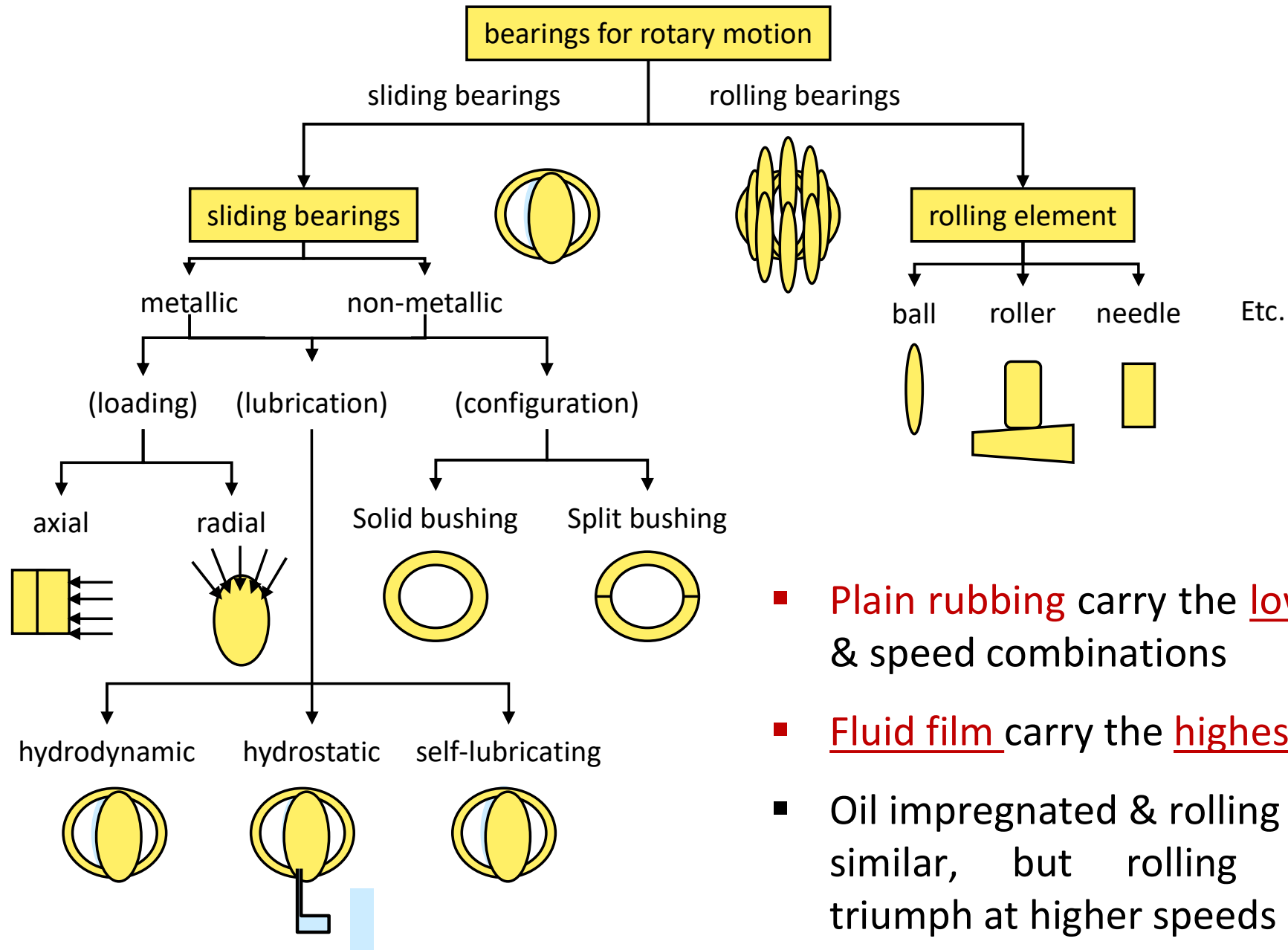

- Plain rubbing carry the lowest load & speed combinations
- Fluid film carry the highest
- Oil impregnated & rolling elements similar, but rolling elements triumph at higher speeds

Bearing Selection

- Rubbing bearing -----
- Oil impregnated -
- Rolling element —————
- Fluid film plain - - - - -

What happens as we increase load and speed?

- Design?
- Materials?
- Cost?

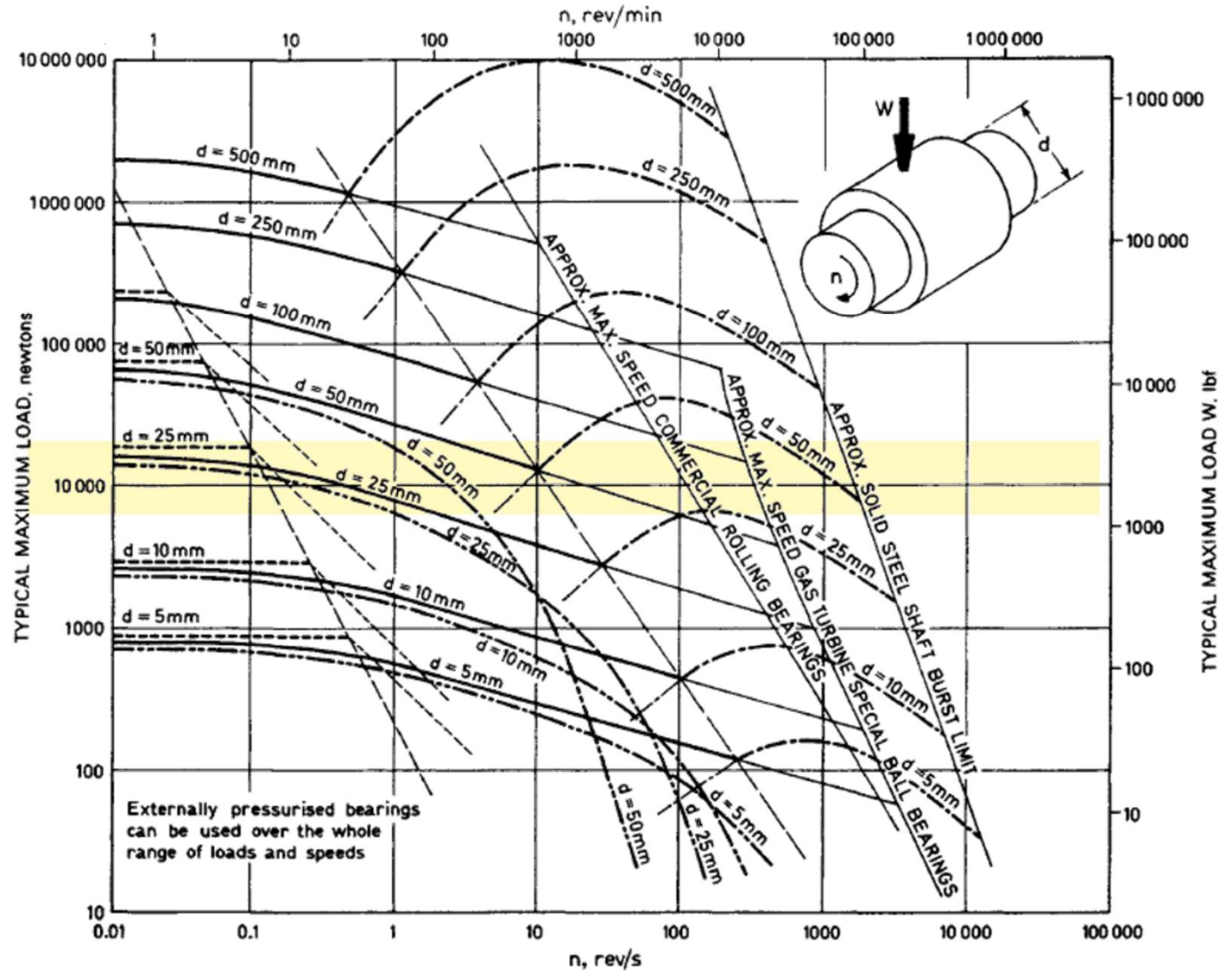

Rubbing Bearings

- A - thermoplastics
- B - PTFE
- C - PTFE + fillers
- D - Porous bronze + PTF + Pb
- E - PTFE-glass weave + thermoset
- F - reinforced thermoset + MoS_2
- G - thermoset/carbon-graphite + PTFE

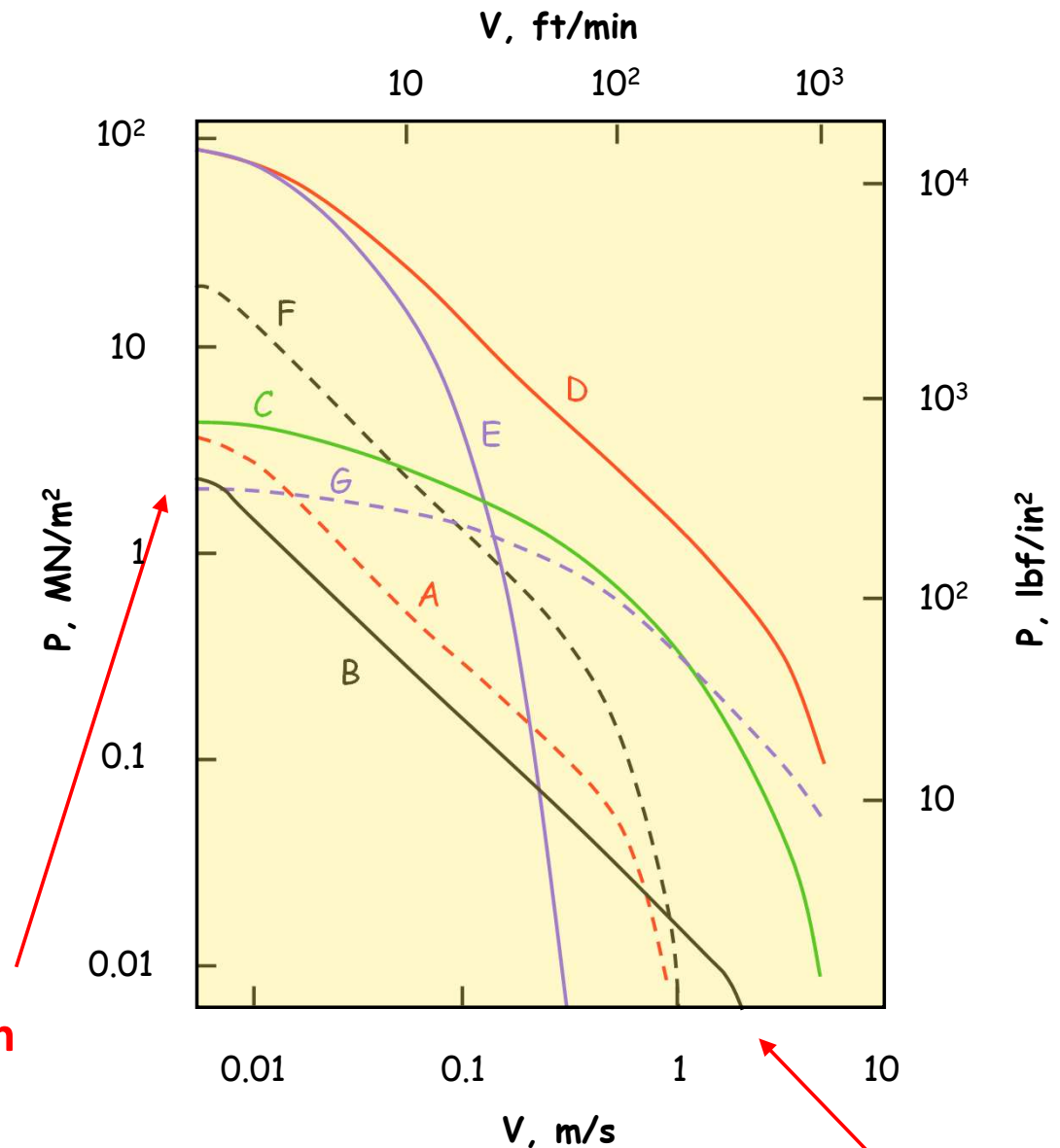

P_{max} limited by strength

V_{max} limited by temperature rise

pV Factor

- A measure of the bearing's ability to cope with frictional heat generation
- Rapid wear occurs if operated at pV_{\max}
- A practical value to use is 50% of pV_{\max}

pV factor

- **pV factor** = base design parameter
- **pV** = maximum allowable combination of nominal bearing pressure and relative sliding velocity.
- If pV is exceeded then overheating, melting and excessive wear or seizure of the bearing will follow.

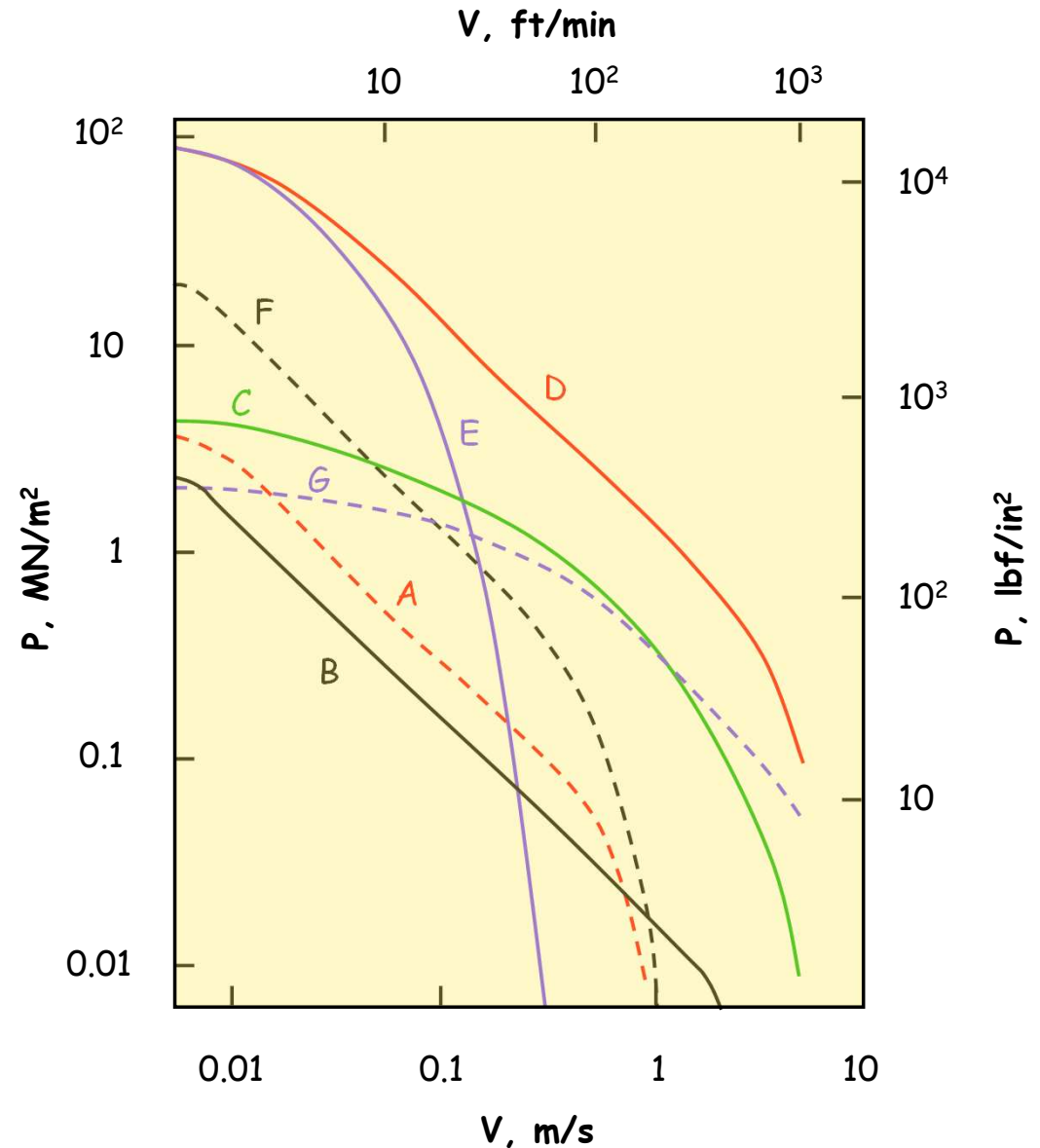

Radial Sliding Bearing (Journal)

Projected Area = bD

Nominal pressure, P

$$= \frac{F_{radial}}{bD}$$

Wear depth = Y

Wear volume, $W = YbD$

Sliding speed, V

$$= \omega \frac{D}{2}$$

$$\omega (\text{rad/s}) = \frac{2\pi n(\text{rpm})}{60}$$

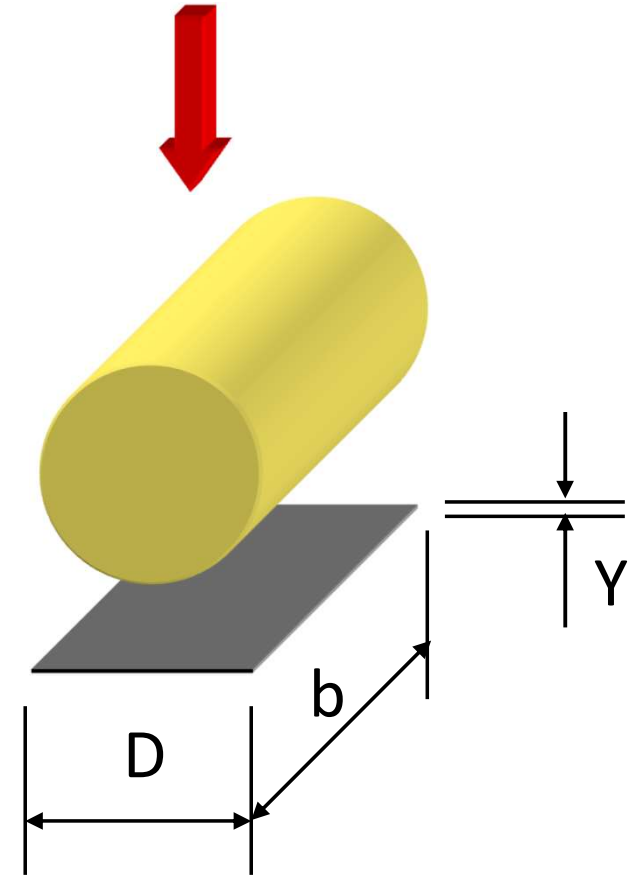

Axial Sliding Bearing (Thrust)

$$\text{Thrust area} = \frac{\pi}{4} (D^2 - d^2)$$

Nominal pressure

$$= \frac{F_{axial}}{\frac{\pi}{4} (D^2 - d^2)}$$

Wear depth = Y

Wear volume,

$$W = Y \frac{\pi}{4} (D^2 - d^2)$$

Sliding speed

$$V = \omega \frac{D + d}{4}$$

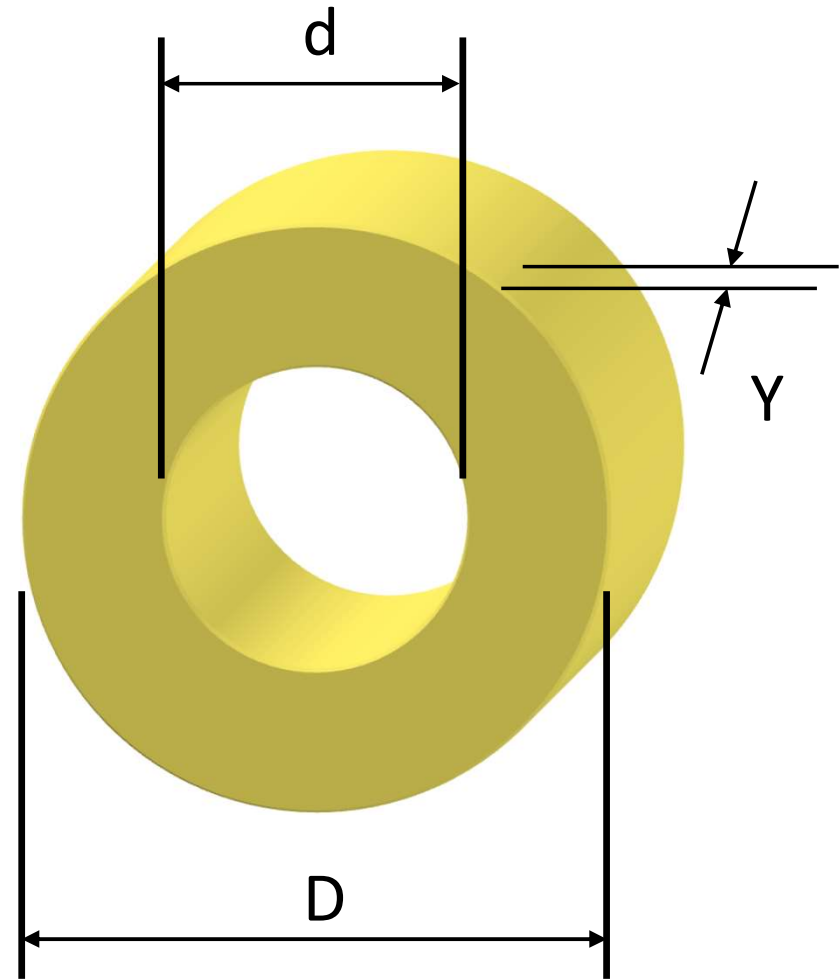

Plain Rubbing Bearings (dry sliding)

- Do not rely on liquid lubrication
- Usually polymeric & moulded to final shape
- Dry lubricants, e.g. **PTFE** are added
- Reinforcements added, e.g. glass fibre
- **Pressure** is limited by strength
- **Speed** is limited by temperature

Oil Lubricated Porous Bearings

- Manufactured from **sintered metal powders**
- Porous (to 30%) & oil impregnated
- More porous = weaker, but higher speeds
- **lubricant** needs to be replenished at regular intervals - typically 1000 hours of use

Material Properties

Metallic and polymer bearings rubbing against a ground steel shaft ($R_a = 0.4 \mu\text{m}$)				
Bearing material	Lubrication	μ	pV (max) MPa m/s	$K \times 10^{-15} \text{ m}^3/\text{Nm}$
Cast iron and lead bronze	Dry	0.2 - 0.5	0.1	10 - 1000
	Grease	0.05 - 0.15	1	0.01 - 1
Porous bronze/graphite	Dry	0.1 - 0.4	0.2	0.5 - 5
Porous bronze	Oil impregnated	0.01 - 0.1	1	0.001 - 0.01
Babbitt metal (steel backed)	Wick lubricated	0.005 - 0.1	2	0.001 - 0.01
PTFE (3 mm thickness)	Dry	0.05 - 0.3	0.05	10 - 1000
Porous bronze impregnated with PTFE and lead (steel backed)	Dry	0.05 - 0.3	1	0.03 - 0.3
Polyoxylene methylene (POM) 0.2 mm thick bonded to porous bronze (steel backed)	Indentations greased during assembly	0.05 - 0.15	1.5	0.003 - 0.03
K = specific wear rate				

Combined Journal & Thrust

- Bearings can be configured to **withstand radial & thrust forces** (with a flange)
- Their performances must be matched (there is no point in thrust capacity failing at 50% of the journal capacity)

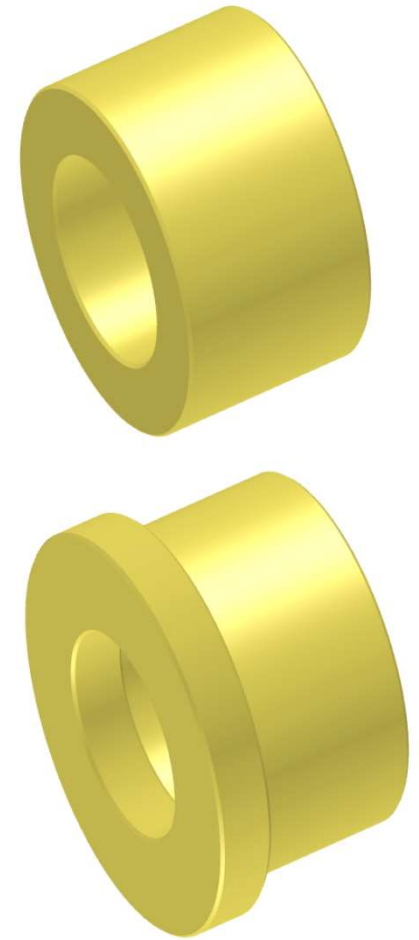

Other Important Factors

- Plain bearings wear
- Design for a given service life (tolerated wear volume)



Wear

- Adjust bearing area and speed to give an **acceptable wear rate (& life)**
- Wear Factor K is provided by the manufacturer
- The wear factor is the wear volume per unit applied load per unit sliding distance:
 - W is wear volume (m^3)
 - F is bearing load (N)
 - V is the sliding velocity (m/s)
 - t is the elapsed time (s)

$$K = \frac{W}{FVt}$$

Manufacture

- Factors to be considered include moulding, machining, assembly, fastening, service, etc.
- Nominal diametral clearance 1 μm per mm is common
- Manufacturing Tolerance
 - close running fit (H8/f7)
 - Free running (H9/d9)

Hydrodynamic Bearing

- Pressure builds in the lubricant as a response to the relative motion
- Both journal and thrust bearings may use this principle
- *BUT* ~ surfaces touch and rub at very low speeds

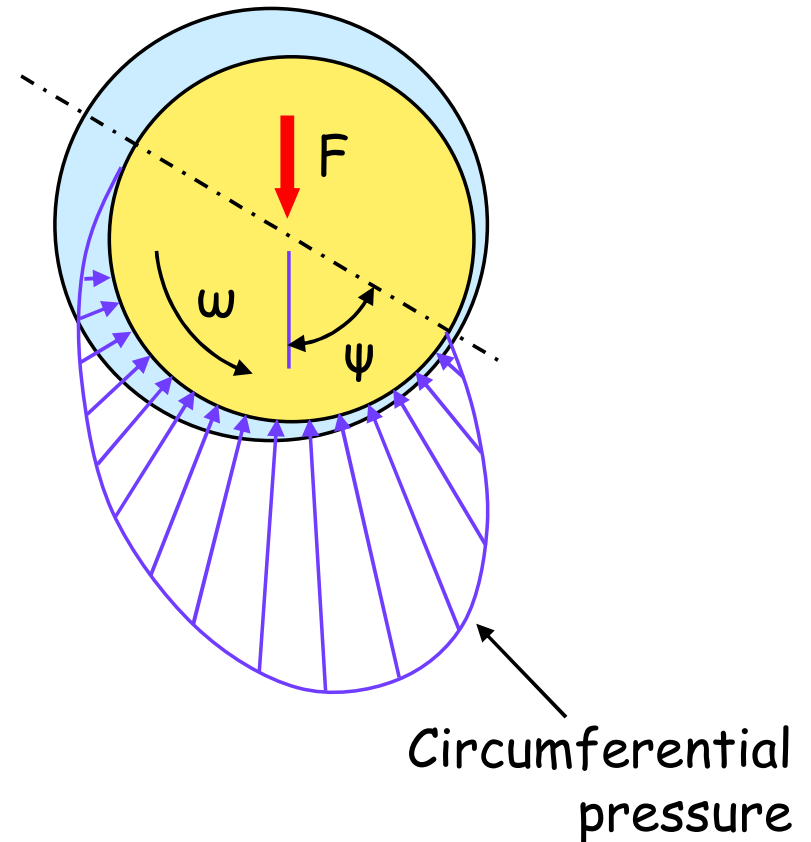

Lubrication Regime

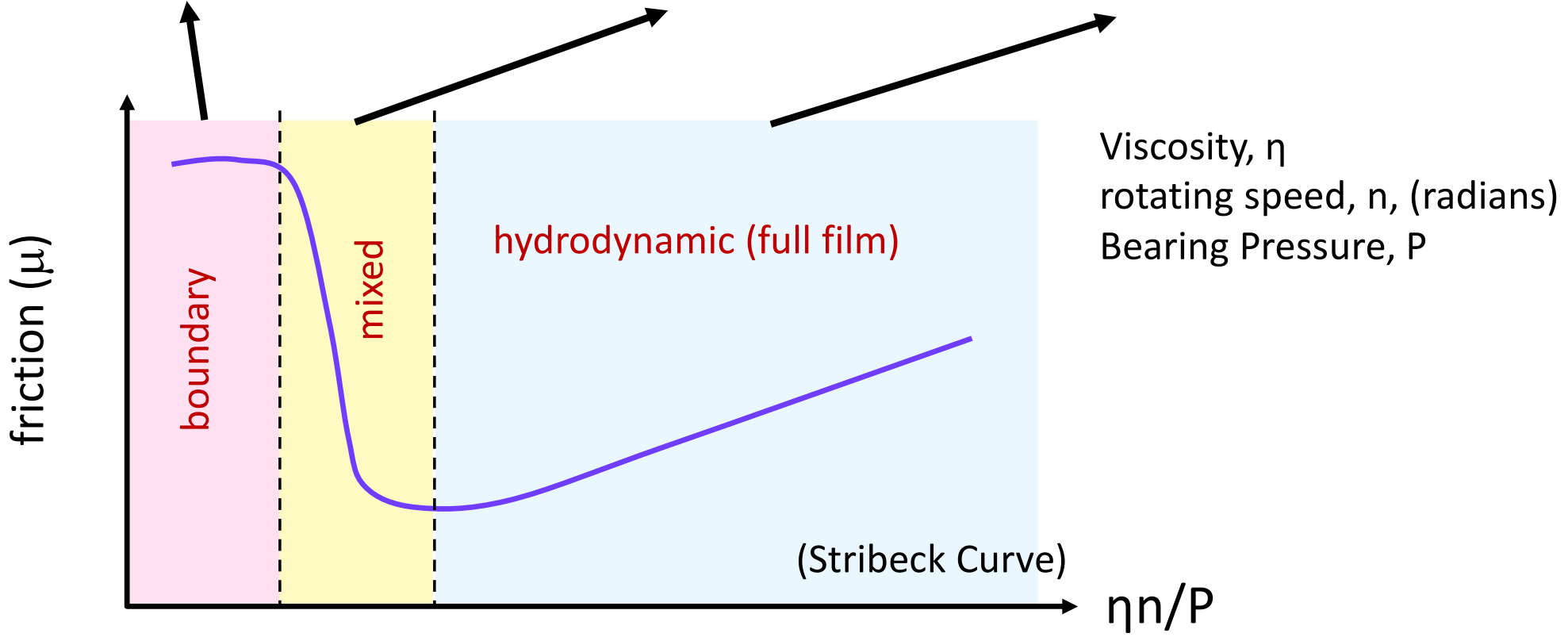
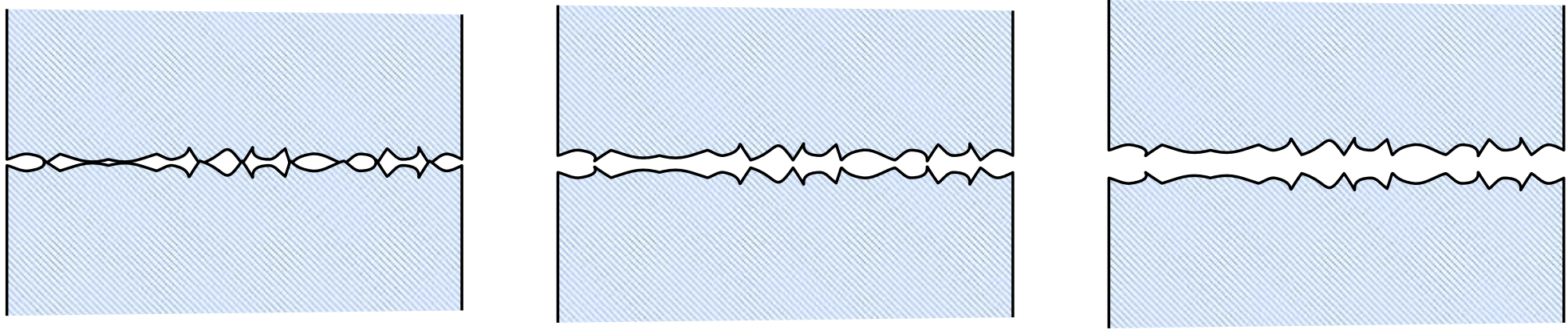

Lubrication Regimes

- Boundary Lubrication
 - continuous & extensive contact
 - lubricant is smeared across the surfaces
 - coefficient of friction (μ) 0.05 to 0.2
 - wear takes place & limits life

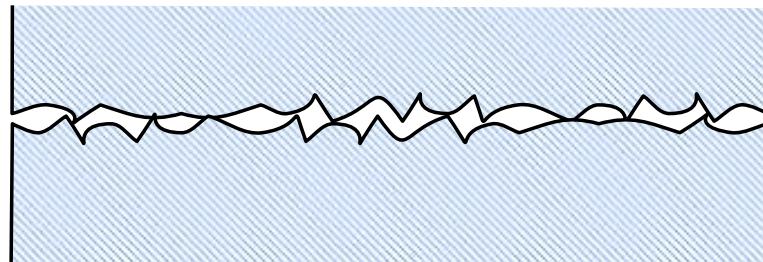

Lubrication Regimes

- Mixed lubrication

- higher surface speeds?
- intermittent contact between asperities
- partial hydrodynamic support
- coefficient of friction (μ) 0.004 to 0.10
- very high local pressures can create elastic deformation of the surfaces- **Elastohydrodynamic lubrication (EHD)**

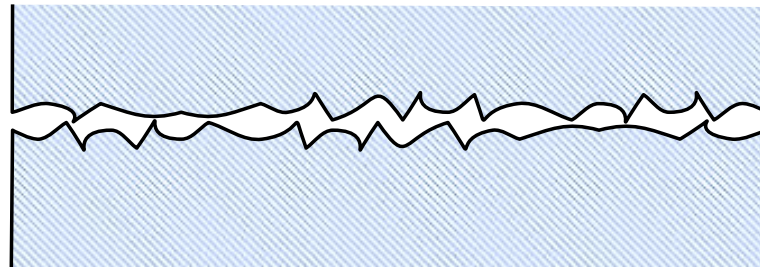

Lubrication Regimes

- hydrodynamic (film, thick film)
 - higher speeds
 - no contact between surfaces & no wear
 - minimum film thickness of 8 μm to 20 μm
 - very good surface finish & tolerances required
 - coefficient of friction (μ) 0.002 to 0.01

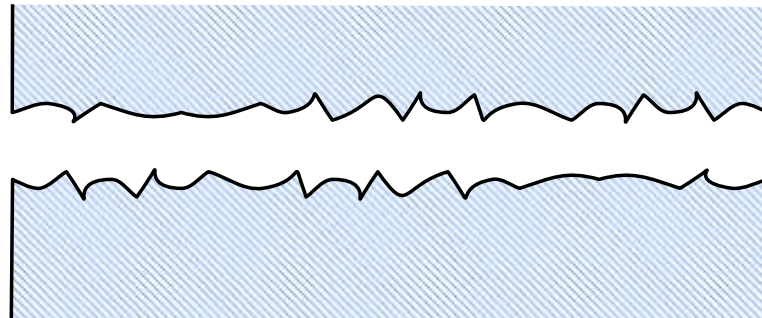

Sommerfeld Number (Bearing characteristic number)

- **Viscosity η** : high viscosity means lower speed film lubrication & high friction (through shear)
- **rotating speed n (radians)**: higher speed means easier establishment of film & more loss (shear rate)
- **Bearing Pressure P ($=F/bD$)**: low pressure means easier 'lift off'
- Sommerfeld Number describes a bearing 'dimensionless' and relates the parameters above with Radius, R and clearance, h

$$h = \frac{\text{bearing diameter} - \text{shaft diameter}}{2}$$

$$S = \left(\frac{R}{h} \right)^2 \frac{\eta n}{P}$$

Petroff's Equation

- friction is predominantly due to shear, which is primarily a function of: gap, speed, viscosity

$$\mu = 2\pi^2 \frac{\eta n R}{P h}$$

- This simple formula is good for lightly loaded bearings

Hydrodynamic Bearing

Hydrodynamic bearing action relies on the creation of a pressure wedge

- in journal

- shaft moves off-axis

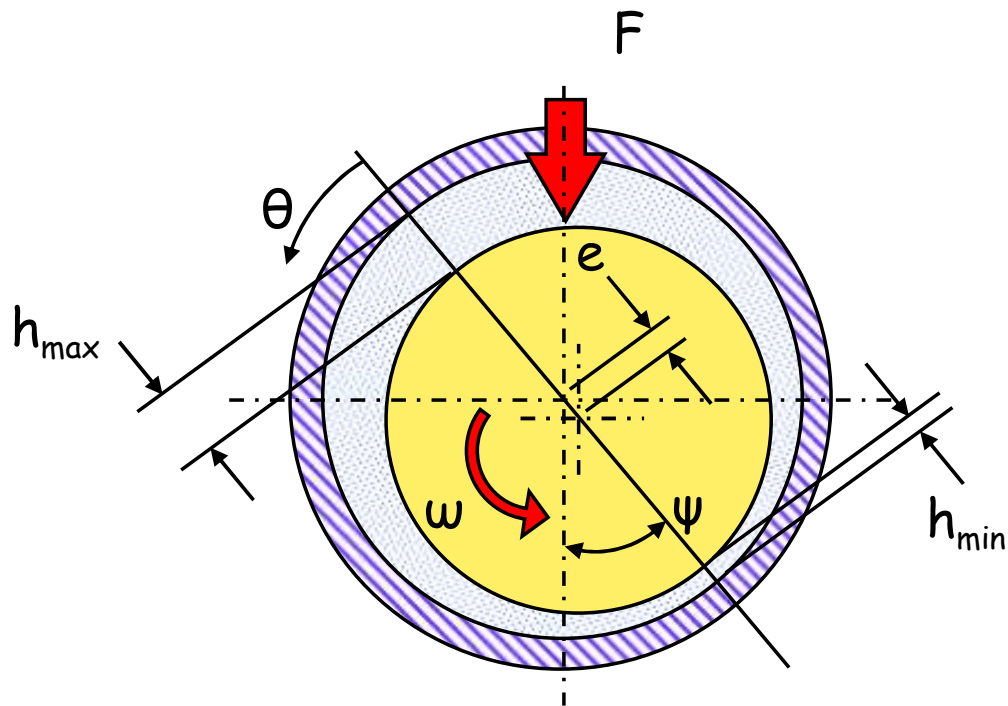

- in thrust

- load carrying capacity depends on size, viscosity & speed

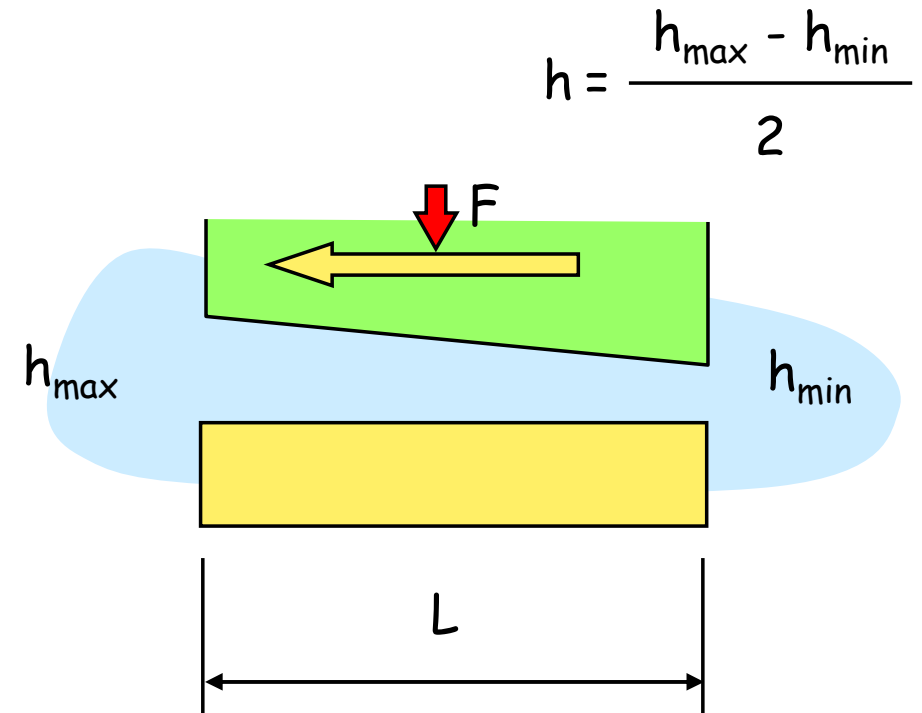

$$h = \frac{h_{max} - h_{min}}{2}$$

Journal Bearing

Load carrying capacity

- for long bearings:

$$F = S\eta V \frac{R^2}{h^2}$$

Goes up with;

- Lubricant flow
- Lubricant viscosity
- Relative sliding speed
- Ratio of radius to clearance

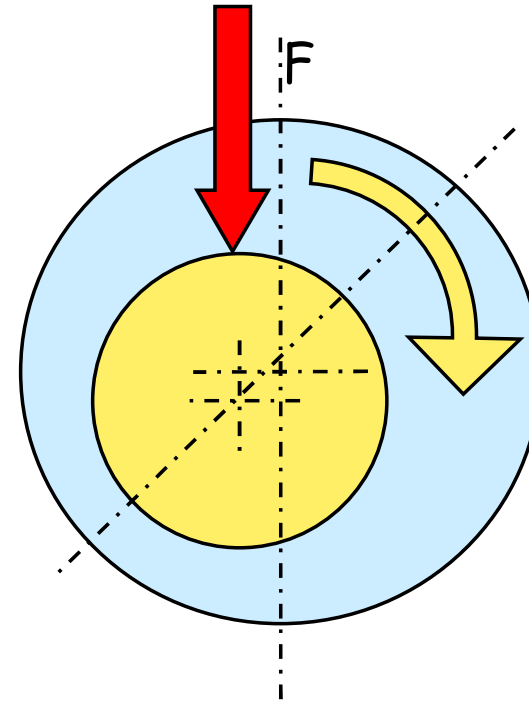

Thrust (Pad) Bearing

- L = length of the bearing surface
- V = sliding velocity
- η = oil viscosity
- h_{\min} and h_{\max} are the minimum and maximum separation between the sliding surfaces
- n is given by:

$$n = \frac{h_{\max}}{h_{\min}} - 1$$

Note the
different
use of n

$$F = 6 \eta \left[\frac{\text{Ln}(1+n)}{n^2} - \frac{2}{n(2+n)} \right] V \frac{L^2}{h_{\min}^2}$$

Thrust Pads

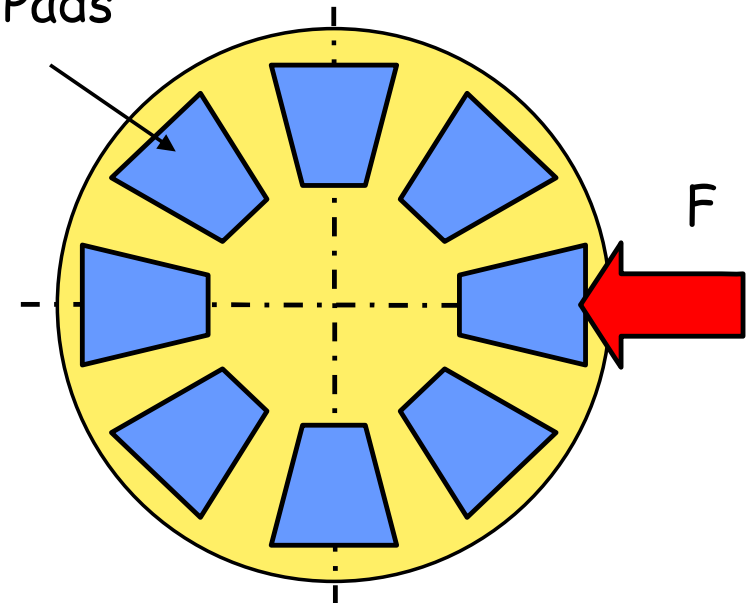

Bearings and Oil Passages in Engines

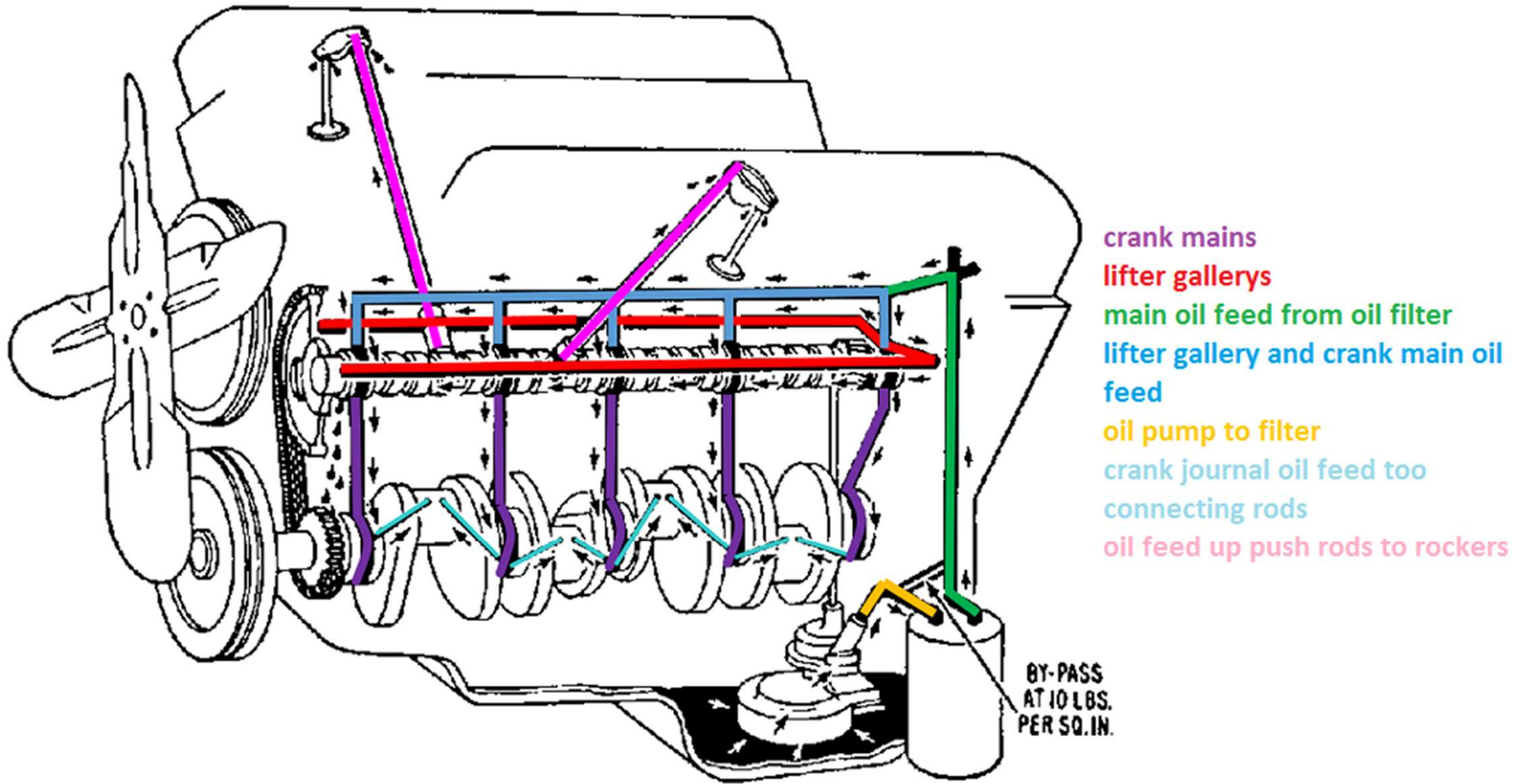

Oil Passages in Engines

LUBRICATION AND VENTILATION

OIL FLOW CIRCUIT

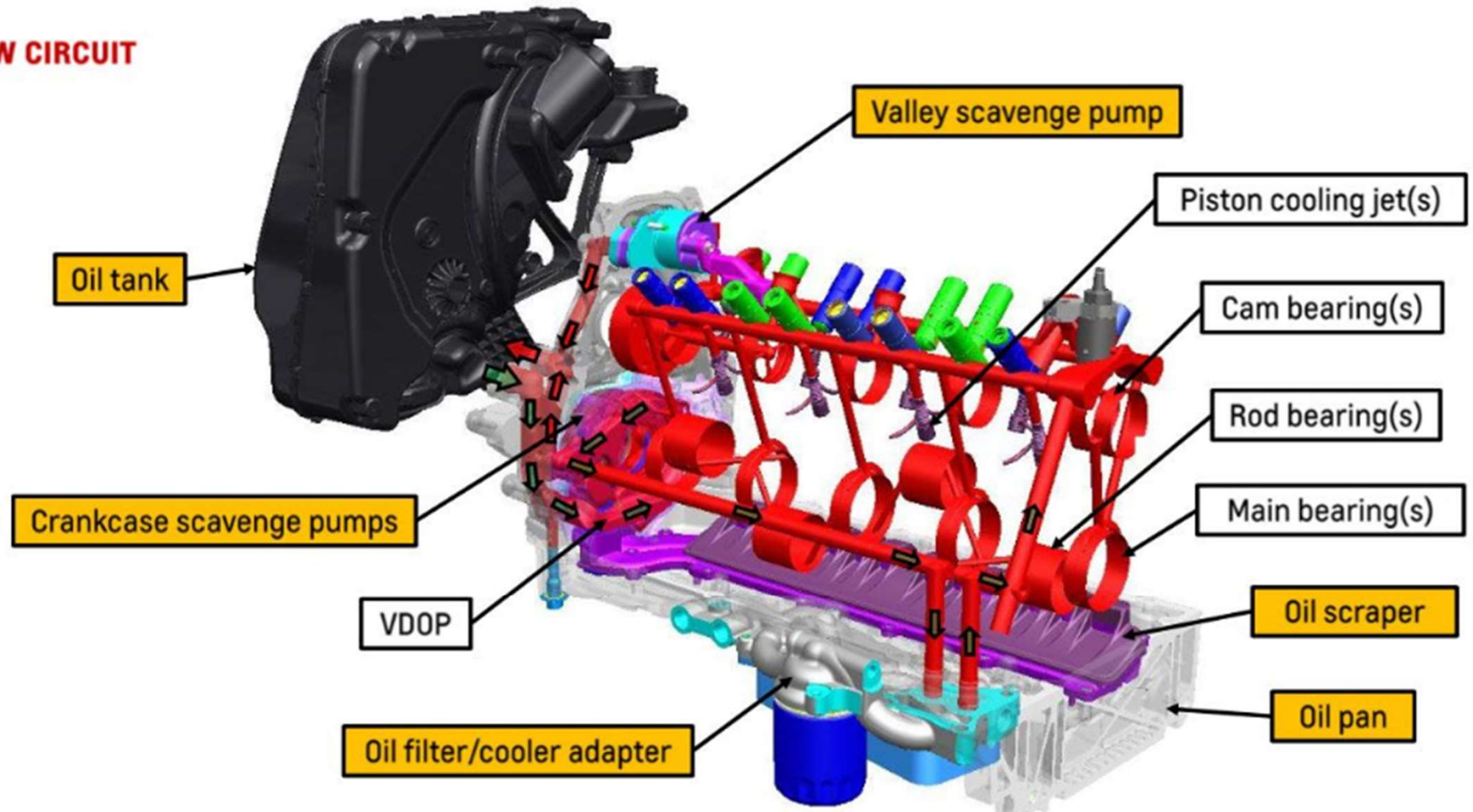

Film Thickness

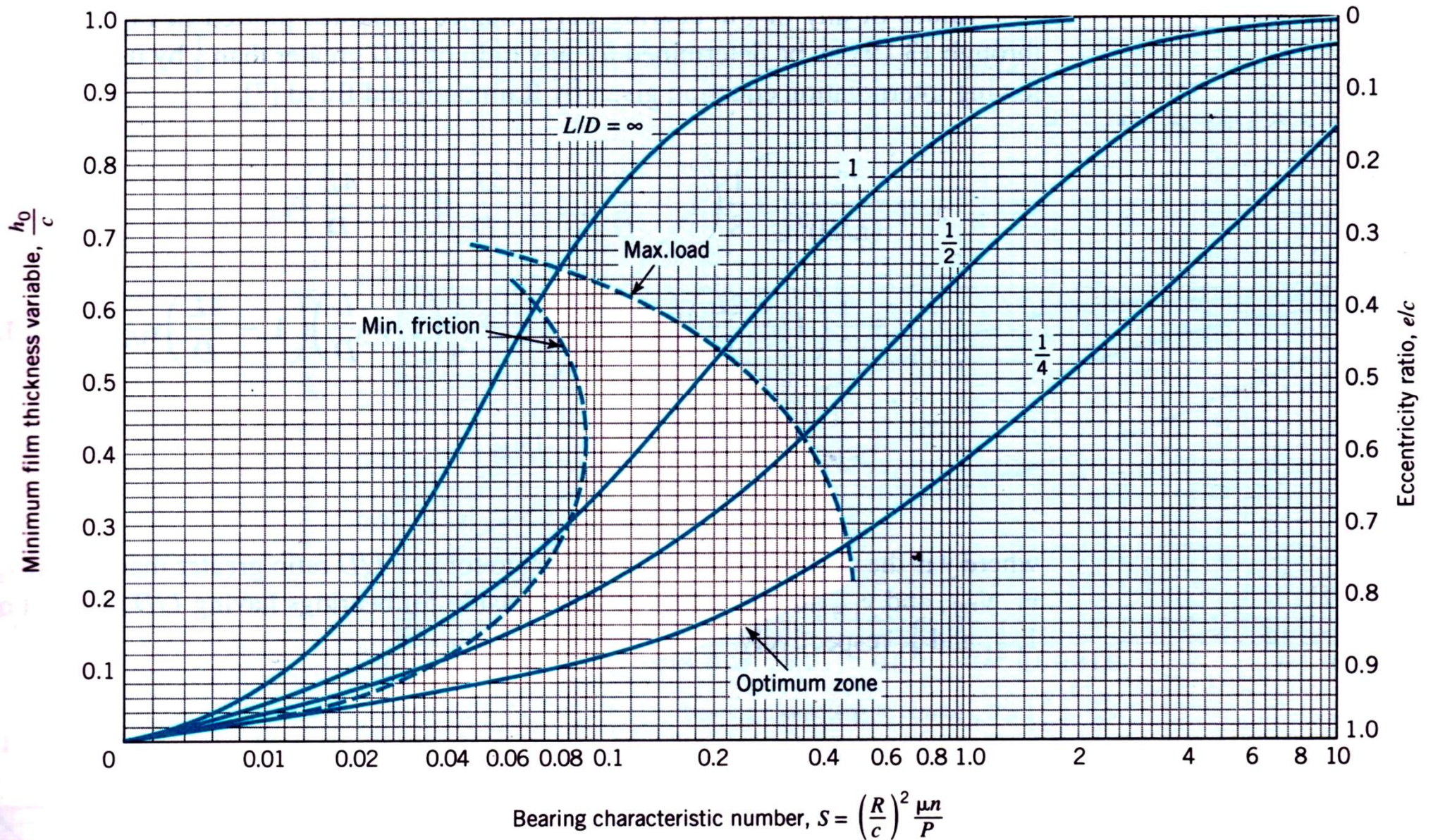

Friction

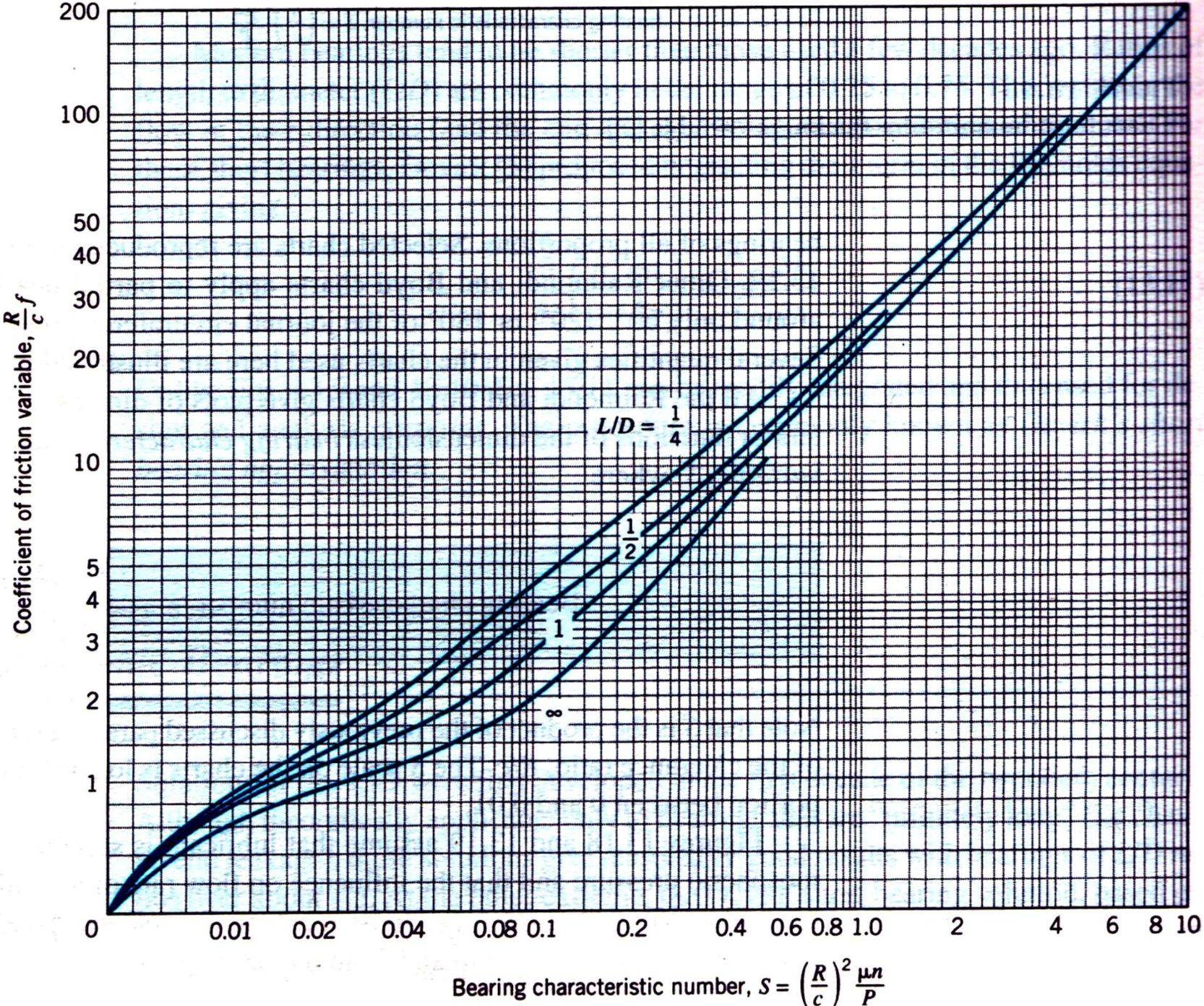

Temperature

- **viscosity** and **density** of most lubricants are highly temperature dependent
- if the temperature rises then viscosity and density will decrease
- as a bearing warms up the Sommerfeld number will decrease as viscosity decreases and the load carrying capacity will also go down.
- designing for stable operating temperature

Viscosity

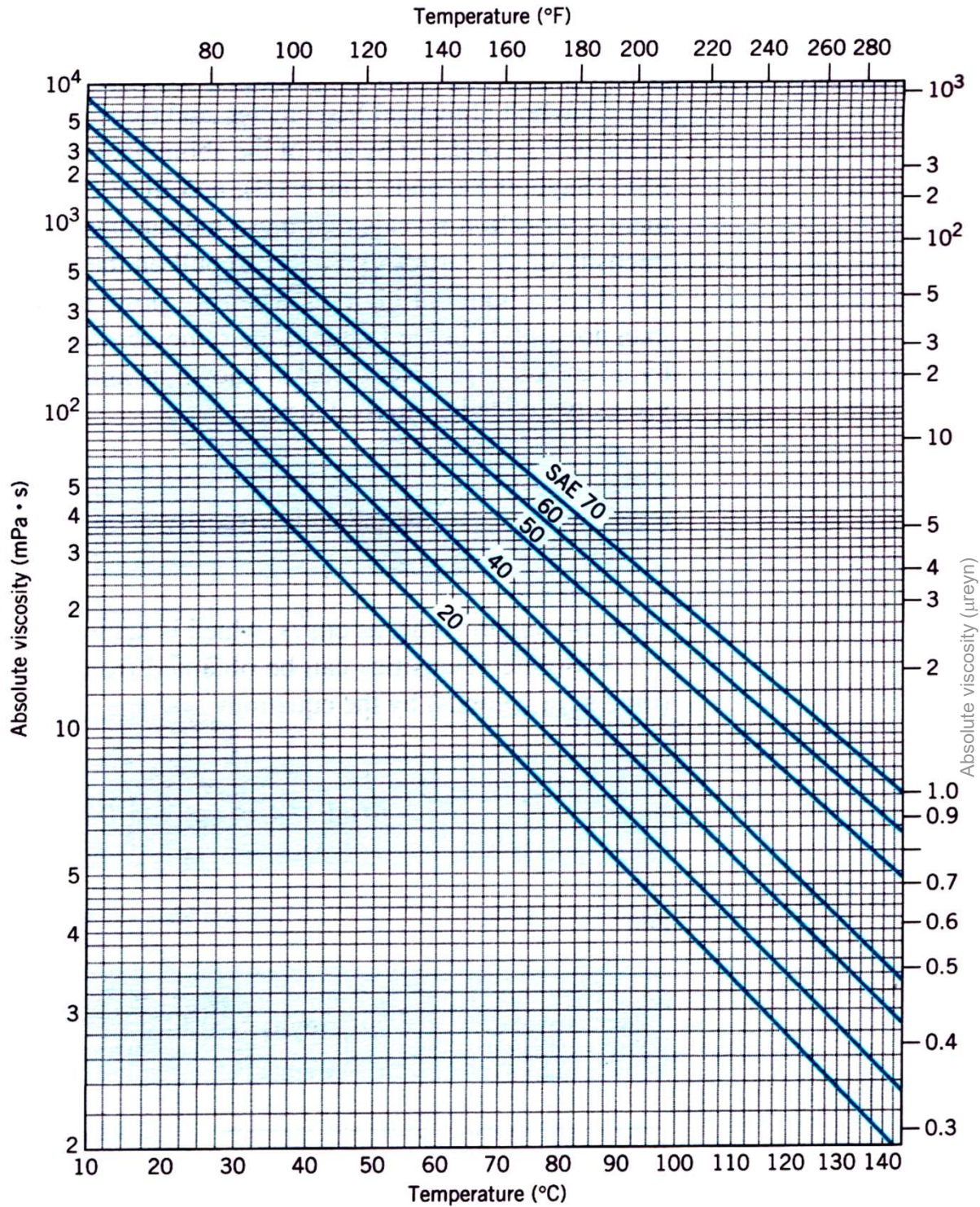

Summary

- Plain rubbing bearings are the simplest bearing and work well for low speeds – Wear is guaranteed to occur
- Self lubricating bearings improve on the performance of plain rubbing bearings but require regular recharging
- Hydrodynamic bearings offer near zero wear so long loads are moderate, the shaft remains in motion and lubricant is available
- Hydrodynamic bearings can provide good load capacity and long life in a small space, but perform poorly with intermittent motion or slow speeds
- Compared to rolling element bearings, sliding bearings
 - consume more energy
 - can offer higher load bearing capacities
 - are less accurate as the axis of rotation varies with load & speed
 - can last “forever” under the right circumstances

Rolling element bearings further reading

- Shigley, J.E., Mische, C.R. and Budynas, R.G., 2003. *Mechanical Engineering Design (7th International Edition)*, McGraw-Hill (George Green Library TJ230 SHI)
- Neale, M.J. (Ed.), 1995 *Tribology Handbook*, Butterworth Heinemann
(https://www.imeche.org.uk/imember/v_library.asp)
- R J Welsh , R.J., 1983. *Plain Bearing Design Handbook*, Butterworths (George Green Library TJ1061 WEL)
- <http://www.skf.co.uk>
- <http://www.nsk.co.uk>
- http://www.rotechconsulting.com/bearings_sub2.htm

Plain bearings further reading

- Shigley, J.E., Mische, C.R. and Budynas, R.G., 2003. *Mechanical Engineering Design (7th International Edition)*, McGraw-Hill (George Green Library TJ230 SHI)
- Neale, M.J. (Ed.), 1995 *Tribology Handbook*, Butterworth Heinemann
(https://www.imeche.org.uk/imember/v_library.asp)
- R J Welsh , R.J., 1983. *Plain Bearing Design Handbook*, Butterworths (George Green Library TJ1061 WEL)

Hydrostatic bearings further reading

- Raimondi, A. and Boyd, J., 1958. A Solution for the Finite Journal Bearing and Its Application to Analysis and Design, Parts I, II, and III. Transactions of American Society of Lubrication Engineers, Vol. 1, No. 1, in Lubrication Science and Technology, Pergamon, New York, 159-209.
- Juvinall, RC and Marshek, KM, 2006. Fundamentals of Machine Component Design (Wiley International student edition), Wiley & Sons, Asia Pty
- Neale, M.J. (Ed.), 1995 *Tribology Handbook*, Butterworth Heinemann
(https://www.imeche.org.uk/imember/v_library.asp)
- www.tribology-abc.com

Revision Questions

- Why are hydrodynamic bearings no good for railway wagon wheel bearings?
- What is different to make hydrodynamic bearings good for engine bearings?
- Would a hydrodynamic bearing be appropriate for a power generation turbine in a coal fired power plant?



University of
Nottingham

UK | CHINA | MALAYSIA

Bearings 1 – Sliding bearings Self lubricating, hydrostatic and hydrodynamic bearings

End of Session